

The
Handy

HOME & GARDENING

MADE EASY



Home & Gardening Range 2025

The Handy

GARDENING MADE EASY



One-stop shop for all your garden needs!

We understand that every job requires the right tool, and that's why we offer a comprehensive range of affordable and reliable garden and DIY tools. Whether you're tackling a DIY project, tilling your garden, moving heavy objects, clearing debris, logging wood, cutting branches, shredding leaves, sawing timber, spraying pesticides, spreading fertilizers, or rolling your lawn, we have the perfect tool for you.

With our commitment to affordability, reliability, and customer satisfaction, The Handy has become a trusted name in the industry. We believe that the right tool can make all the difference in achieving your desired results, and we are here to help you find that perfect tool.





Family-Run Business with Traditional Values

At The Handy, we take pride in being a family-owned business with traditional values. With a dedicated team of over 45 experienced staff working at our headoffice in Swindon, we ensure that our customers receive not only quality products but also exceptional knowledge and aftersales support. Many of our staff members have been part of the garden machinery industry for years, bringing their expertise and insights to help you make informed decisions.

Versatile Product Range

Our product range includes a variety of tools powered by petrol, electricity, or simple hand-operated mechanisms. We understand that different tasks require different power sources, and we strive to provide options that cater to your specific needs. Whether you prefer the convenience of electric tools, the versatility of petrol-powered devices, or the simplicity of hand-operated tools, we have you covered.

Explore our range of products, and let us assist you in transforming your garden and DIY projects.



Contents

Aerators	4
Garden Blowers, Vacuums and Sweepers	10
Garden Rollers	16
Hand Push Lawnmower	20
Grass and Shrub Shears	22
Spreaders	24
Tillers	34
Log Splitters and Accessories	38
Saw Horses	44
Shredders	48
Garden Sprayers	52
Transportation	56
Vacuums	62

Aerators

For maintaining a healthy and vibrant lawn or garden

Aerators play a crucial role in alleviating soil compaction, improving nutrient absorption, and promoting deep-root growth. By creating small holes in the soil, garden aerators enhance the overall health and appearance of outdoor spaces, resulting in lush and thriving landscapes.



Long-Term Lawn Maintenance

Whether you are a passionate gardener or simply want to keep your lawn in top shape, investing in a garden aerator is a wise decision for long-term landscape maintenance.



Hollow Tine Aerator

THBHTA

The easy way to improve lawn quality

The easy way to improve lawn quality with this straightforward manual hollow tine aerator from Handy, gardeners looking for a simple and cost-effective way to relieve the hard and dry sections of your lawn due to soil compaction should check this out. It's all steel construction, so it will prove strong and durable. It removes five soil cores in one action. In addition, it will minimise moss proliferation and allow any fertiliser or dressing you apply to work more effectively. Its five hollow tines remove soil cores down to a depth of 50mm, enabling water, air, and nutrients to better access the root network to encourage lush, healthy growth. Also featured is a tread plate that makes it easy to dig in the tines. This model has a 20cm working width and weighs just 2.5kg.



Specifications

Working Width	20cm / 8"	Construction	Painted Steel
Tine Type	Hollow Tine	Height	97.5cm / 38"
Tines	5	Aerating Depth	5cm / 2"
Spring Assisted	No	Weight	2.5kg
Collection Tray	No	Warranty	2 Years
Handle	Steel		



Features & Benefits



STEEL CONSTRUCTION

The THBHTA is constructed from durable steel to ensure a long life.



TREAD PLATE

The integrated tread plate allows the tines to penetrate the soil with ease.

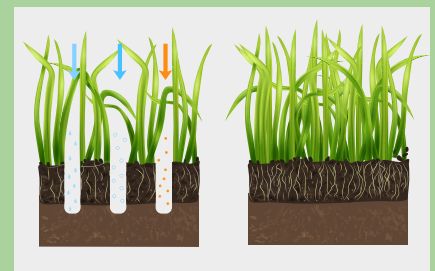

GREENER, HEALTHIER, LAWN

By removing cores of soil, water, sunlight and nutrients can reach the grass roots resulting in a healthier appearance.

Spring Hollow Tine Aerator

THHTA

Aerate in comfort with enhanced features

Equipped with five powerful hollow metal tines, this aerator is a force to be reckoned with. It effortlessly removes soil plugs up to 50mm deep, allowing essential nutrients, water, and oxygen to reach the grassroots for a revitalised and lush lawn. The tread plate ensures easy penetration, even in compacted soil, making the aeration process smooth and efficient. With a user-friendly design that requires only the pressure of your body weight, the Spring Hollow Tine Aerator is suitable for all lawn types.

The included collection tray prevents soil plugs from cluttering your lawn post-aeration, and the lightweight 3kg build, along with a soft handle, ensures comfortable operation.

Specifications

Working Width	28.5cm / 11"	Construction	Painted Steel
Tine Type	Hollow Tine	Height	97.5cm / 38"
Tines	5	Aerating Depth	5cm / 2"
Spring Assisted	Yes	Weight	3kg
Collection Tray	Yes	Warranty	2 Years
Handle	Cushioned Grip		

Features & Benefits

SPRING ASSISTED TINES

Each tine is surrounded by a heavy duty spring, allowing easy removal from the lawn surface during use.



COLLECTION TRAY

The collection tray conveniently collects soil cores for easy disposal during use.



Looking for an aerator to cover larger areas?

Try The Handy towed models with a wide working width of up to 48" on [page 8 & 9](#)



Towed Plug Aerator 101cm / 40"

THTPA40

The easy way to aerate larger lawns

Elevate your lawn care routine with this highly efficient aerator, designed to effortlessly attach to your garden tractor or ride-on mower. By harnessing its ingenious design, the aerator extracts plugs of soil, facilitating the infusion of essential oxygen, water, and nutrients deep into the grassroots, thereby fostering the growth of a lush and healthy green lawn.

Its 24 sharp metal corers penetrate the soil with precision, while the generous 101cm width ensures efficient and rapid aeration over a significant area. Plus, the adjustable depth feature allows you to adapt the soil plugs to your preference, up to a maximum length of 7.6cm (3"), all controlled with a convenient one-handed lift lever. Crafted with rugged steel, a heavy-duty weight tray, and robust 10" pneumatic wheels, this aerator handles even the toughest soil.

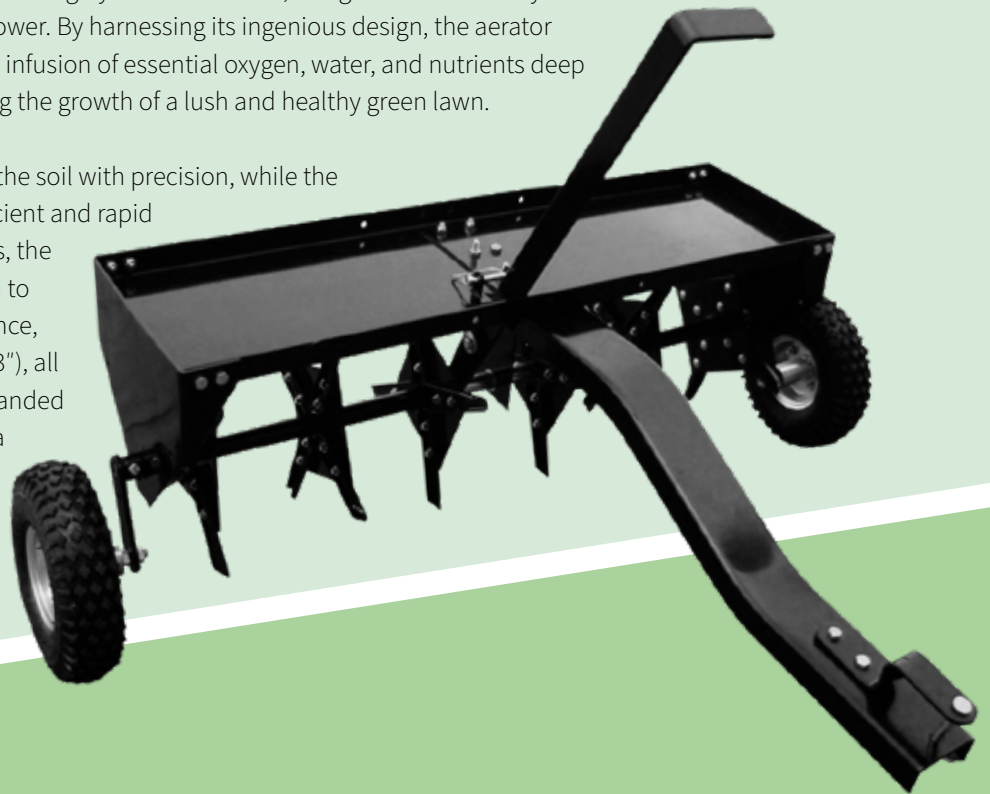

Specifications

Working Width	101cm / 40"	Tyres	Pneumatic 10.5x4"
Tine Type	Hollow Plug	Hitch Type	Pin
Tines	24	Modes	Transport / Working
Aeration Depth	7.6 cm / 3"	Dimensions (cm)	L133 x W99 x H85
Tray Load Capacity	45kg	Weight	33kg
Construction	Steel	Warranty	2 years



Features & Benefits



IDEAL FOR MEDIUM TO LARGE GARDENS

Simply hitch the aerator to your garden tractor or ride-on mower to remove plugs of soil.



FAST AND EFFECTIVE AERATING

24 sharp metal corers that cut firmly into the soil and a wide 101cm width means you cover a large area quickly.



ADJUSTABLE DEPTH

For shorter or longer soil plugs up to a maximum of 7.6 cm (3") long.

Towed Plug Aerator 121cm / 48"

THTPA48

Aerate the largest grass areas

Introducing the Towed Plug Hollow Tine Aerator, a powerhouse solution designed for larger gardens to achieve that picture-perfect, lawn you've always dreamed of. This aerator effortlessly attaches to your garden tractor or ride-on mower, swiftly removing plugs of soil and allowing vital elements like oxygen, water, and nutrients to penetrate down to the grassroots, fostering a lush and robust green expanse. Boasting 32 precision-engineered sharp metal corers, it slices into the soil with unwavering precision, while the expansive 121cm width ensures you cover extensive areas with remarkable speed and efficiency.



Specifications

Working Width	121cm / 48"	Tyres	Pneumatic 10.5x4"
Tine Type	Hollow Plug	Hitch Type	Pin
Tines	32	Modes	Transport / Working
Aeration Depth	7.6cm / 3"	Dimensions (cm)	L154 x W95 x H66
Tray Load Capacity	63.5kg	Weight	42kg
Construction	Steel	Warranty	2 years



Features & Benefits



BEFORE AERATION

Over time material builds up on the lawn surface preventing the roots from receiving nutrients.

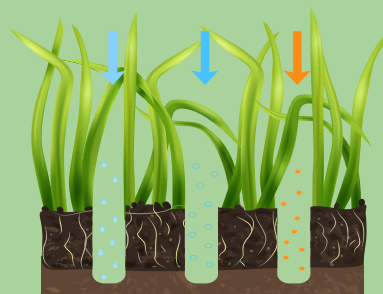

DURING AERATION

Cores of soil are removed which allow sun, air and water to reach the grass roots.



AFTER AERATION

Roots grow stronger, leaving a thicker healthier and greener lawn.

Blower/Vacuums & Sweepers

Clean & Tidy Gardens

The Handy's high-performance garden vacuum/leaf blower and sweeper offer an effective solution to tackle various cleaning tasks with ease and efficiency.

Whether it's tidying up after gardening or clearing fallen leaves, these versatile tools make short work of the job, ensuring a pristine and well-maintained lawn.





The Easy Way to Clean Up

With their powerful performance, these multi-functional devices simplify tasks like removing leaves, hedge trimmings, grass clippings, and other debris from the lawn.

3000w Garden Blower/Vacuum

THEV3000

Keep your garden looking tidy with this blower, vacuum, mulcher and shredder

Featuring a robust 3000W motor and an extended 10-meter power cable, this leaf blower/vacuum is your ideal companion for tackling demanding, large-scale outdoor clean-up tasks. Its integrated shredding system efficiently reduces leaves by 1/10 of the size into easily disposable mulch, while the variable speed control adds versatility to its use. Weighing in at just 4.3kg, it also comes equipped with a comfortable shoulder strap for added convenience.

Leaf blowers, like this one, prove to be versatile tools with year-round utility. They offer seamless clean-up solutions not only during autumn but also throughout every season, making light work of post-pruning or the removal of grass clippings.



Specifications

Power	3000 W
Functions	Blow, Vac/Mulch
Max Airspeed	270 km/h
Max Airflow	720 m ³ /h
Collector	45 L
Mulching Ration	10:1

Construction	Durable ABS
Wheels	Yes
Shoulder Strap	Yes
Cable	10m
Weight	4.5kg
Warranty	2 years



Features & Benefits



BLOWER & VACUUM MODES

Quickly switch from blower to vacuum with the flick of a switch. Vacuum mode also shreds material to a 10:1 reduction ratio.



VARIABLE SPEED

Adjust the blowing speed according to the job in hand, with variable speed control from 150-270km/h.



INTEGRATED WHEELS

As well as featuring a shoulder strap the THEV3000 also has integrated support wheels to reduce the weight of the machine.

Lawn Sweeper 66cm / 26"



THPLS

The easy way to clear away leaves

The Handy THPLS Push Lawn and Leaf Sweeper boasts a generous 66cm sweep-width, so you'll enjoy excellent productivity and will cover lots of ground with every pass. Its durable sweeper-brush is powered by the action of the wheels on the ground, and with the brush rotating 4.5 times for every turn of those wheels, a thorough pick-up and a neat, debris-free lawn is guaranteed.

Perfect for sweeping leaves, moss and thatch from scarifying, soil cores from aeration and much more.



Combining a substantial 66cm working width with a hugely roomy 200-litre collector, this practical and convenient push-type sweeper from Handy will make tackling the autumn leaf deluge a breeze! Features include height adjustment for multi-surface use; and large 25cm-diameter wheels for excellent traction.

Specifications

Drive	Push
-------	------

Width	66cm / 26"
-------	------------

Collector	200 L
-----------	-------

Sweeping Height	Adjustable
-----------------	------------

Wheels	25cm / 10"
--------	------------

Frame	Steel
-------	-------

Container	PVC
-----------	-----

Weight	15kg
--------	------

Warranty	2 years
----------	---------

Dimensions (cm)	L124 x W83 x H77
-----------------	------------------



Features & Benefits



PERFORMANCE SWEEPING

The large 25cm sweeper bristles make light work of garden debris by spinning when pushed.



LARGE COLLECTOR

The large 200 L collector can be easily removed from the sweeper for emptying.



QUICK HEIGHT ADJUSTMENT

Depending on the job in hand the sweeper height can be quickly adjusted without tools.

Towed Lawn Sweeper 96cm / 38"

THTLS38

Clear away leaves from large lawns fast

This impressively productive tractor-towed lawn sweeper has an immensely capacious 280-litre collector with a 96cm working width to enable it to cover large areas with speed and efficiency. Working-height adjustment offers multi-surface versatility, while large-diameter wheels provide superior traction. Suitable for use with most makes and models of lawn and garden tractors.

It comes with a massively roomy 280-litre debris bag, so you'll enjoy extended periods of operation between emptying, and it benefits from an adjustable working height that means you'll be able to achieve great results on a variety of surface types (the adjustment is super-simple using only one lever).



Specifications

Drive	Towed
Hitch Type	Pin
Width	96cm / 38"
Collector	280 L
Sweeping Height	Adjustable
Wheels	26cm / 10"

Dimensions (cm)	L183 x W125 x H60
Frame	Steel
Container	PVC
Weight	31kg
Warranty	2 year



Features & Benefits

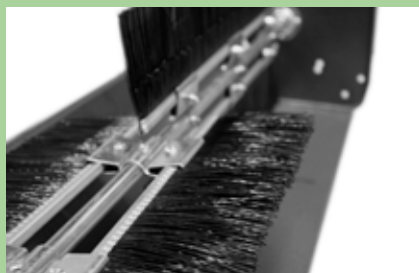

PRODUCTIVE SWEEPING

Highly productive thanks to its sizeable 96cm sweep-width.



LARGE COLLECTOR

280-litre debris collection bag, so you'll enjoy extended periods of operation.



MULTI-SURFACE VERSATILITY

Depending on the job in hand the sweeper height can be quickly adjusted without tools.

Towed Lawn Sweeper 106cm / 42

THTLS42

Clear the biggest lawns with ease

Our Towed Lawn Sweeper is a game-changer for swift, hassle-free lawn cleanup. Its expansive 106cm (42") width and substantial 25cm (10") brush diameter covers large areas with ease.

Easily adjust the brush height with a single lever to collect various debris, from fallen leaves to twigs allowing sunlight, air and moisture to penetrate the root system of your lawn.



Specifications

Drive	Towed	Dimensions (cm)	L183 x W125 x H60
Hitch Type	Pin	Frame	Steel
Width	106cm / 42"	Container	PVC
Collector	310 L	Weight	33kg
Sweeping Height	Adjustable	Warranty	2 year
Wheels	26cm / 10"		



Garden Rollers

The Easy Way to a Level Lawn

The Handy Range of Garden Rollers offers an array of innovative products designed to make your gardening tasks more efficient and effortless. Whether you're aiming to flatten down mole hills, frost-heaves, or cultivated soil; or simply want to create a smart lawn-stripe, our garden rollers are here to lend a helping hand.



The Perfect Roller

With a variety of options to choose from, including convenient hand-push models and convenient tow-along rollers, we have the perfect solution for every gardener.

Explore our range and uncover the time and effort-saving benefits of The Handy Garden Roller.



Garden Rollers



Garden Roller 42cm (16.5")

THSGR

Achieve the perfect lump and bump-free lawn with this simple but effective 42cm garden-roller from The Handy! It weighs only 7kg when empty, so you'll find it easy to shift to and from the shed; and it's fitted with a soft-grip handle that makes it comfortable to use.

Specifications

Type	Push Roller
Width	42cm / 16.5"
Drum Diameter	30cm / 12"
Weight with Water	33kg
Weight with Sand	47kg
Dry Weight	7kg



Garden Roller 48cm (19")

THGR

Enjoy a step up in productivity and smooth out lumps and bumps over larger areas quickly and efficiently with the 48cm THGR Garden Roller! It's equipped with a soft grip handle that makes it comfortable to use; and it weighs a mere 12kg empty. Assembly is fast and hassle-free.

Type	Push Roller
Width	48cm / 19"
Drum Diameter	42cm / 16.5"
Weight with Water	72kg
Weight with Sand	120kg
Dry Weight	14.5kg



Poly Garden Roller 60cm (24")

THGR60P

The THGR60P is the smallest towed roller in the range with a 60cm / 24" working width. Quality steel frame for durability and heavy duty poly roller which has a 101 L capacity for efficient rolling weight.

Type	Push / Towed Roller
Width	60cm / 24"
Drum Diameter	45cm / 18"
Weight with Water	100kg
Weight with Sand	110kg
Dry Weight	13.7kg

Features & Benefits



ADJUSTABLE SCRAPER BAR

The scraper bar can be adjusted to ensure debris is cleared from the roller on some models.



CUSHIONED HANDLE

The THSGR and THGR feature durable cushioned grips for added comfort during use.



FILL WITH SAND OR WATER

All The Handy rollers can be filled with sand or water depending on the weight required.

As well as levelling and striping lawns, garden rollers are perfect for rolling seed into the surface.



Poly Garden Roller 92cm (36")

THGR92P

The THGR92P has a large 92cm / 36" working width. Quality steel frame for durability and heavy duty poly roller which has a 152 L capacity for efficient rolling weight.

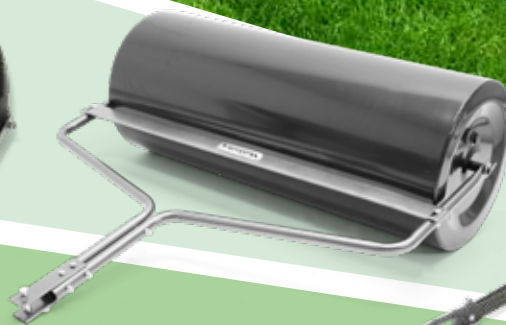

Garden Roller 92cm (36")

THTGR

Whether you're looking to flatten-down mole-hills, frost-heaves or cultivated soil; or simply want to create a smart lawn-stripe, this highly effective towed garden-roller from Handy will prove the perfect purchase!



Poly Garden Roller 122cm (48")

THGR122P

The THGR122P is the largest towed roller in the range with an impressive 122cm / 48" working width. Quality steel frame for durability and heavy duty poly roller which has a 195 L capacity for efficient rolling weight.

Specifications

Type	Towed Roller
Width	92cm / 36"
Drum Diameter	45cm / 18"
Weight with Water	135kg
Weight with Sand	180kg
Dry Weight	19.7kg

Type	Towed Roller
Width	98cm / 38.5"
Drum Diameter	40cm / 15"
Weight with Water	121kg
Weight with Sand	219kg
Dry Weight	21.5kg

Type	Towed Roller
Width	122cm / 48"
Drum Diameter	45cm / 18"
Weight with Water	175kg
Weight with Sand	230kg
Dry Weight	25.1kg

Features & Benefits



IDEAL FOR LARGE GARDENS

Simply hitch the roller to your garden tractor or ride-on mower to roll large areas with ease.



FORMAL STRIPED EFFECT

The Handy towed rollers leave a traditional striped effect across larger lawns.



Lawnmower

Cordless Freedom

Embrace the freedom of a cordless experience as you effortlessly manoeuvre our hand push cylinder lawn mower across your lawn.

No more worrying about finding a nearby power source or dealing with tangled cables that restrict your movement. The hand push lawn mower eliminates these inconveniences, providing a hassle-free mowing experience. Not only does this lawn mower offer convenience, but it also contributes to a greener and more sustainable environment.



The
Handy

Cylinder Push Mower

THHM

The easy way to a beautiful lawn

Look after a smaller lawn the simple, eco-friendly way with this compact and easy to operate hand cylinder mower from The Handy!

Features include a rear mounted grass catcher that means you'll be able to leave your rake in the shed; a rear roller for an attractive striped effect; and an adjustable cutting height for a precision finish from 17-43mm. The Handy THHM Hand Cylinder-Mower weighs just over 7kg.



Specifications

Drive	Push	Blades	5
Width	30cm / 12"	Construction	Steel
Collector	18 L	Dimensions (cm)	L90 x W45 x H90
Height of Cut	17-43mm	Weight	7.5kg
Blade Type	Cylinder	Warranty	2 years



Features & Benefits



THE CLEANEST CUT

Cylinder mowers are renowned for their clean cut, with the cylinder blade rotating next to a fixed bottom blade to cut in a similar way to scissors.



GRASS COLLECTOR

Depending on the area being cut, the 18 L collector can be easily attached to catch grass clippings to leave a formal finish.



QUICK ADJUSTMENT

The simple wingnut allows height adjustment between 17-43mm to suit different types of lawn from formal to more natural.

Grass & Shrub Shears

Maintain Shrubs and Lawn Edges

Introducing our cordless handheld shrub shears – the handy way to shape and sculpt your outdoor spaces.

With optimized ergonomics and cutting-edge lithium battery technology, these shears make maintaining shrubs, bushes, and lawn edges a breeze. Experience cordless convenience, reliable power, and comfortable handling as you effortlessly transform your landscape. Create beautifully manicured outdoor spaces with ease using our innovative shrub shears.



Shrub & Grass Shear Kit

THGSS

Keep everything looking trim

This lightweight, handheld shrub shear would be a helpful addition to your garden equipment.

Supplied with two interchangeable cutting heads, one for grass and one for shaping hedges and with the integrated lithium-ion battery you have a flexible and low maintenance tool. With the ergonomic handle & weighing just 0.5kg, with the heaviest cutting head attached, it's a perfect tool to shape the smaller hedge or grass edge in your garden.



Specifications

Power	Battery	Run Time	Shrub Shears 45mins
Battery Type	Lithium Ion		Grass Shears 25mins
Battery Voltage	3.6V / 1.5Ah	Charge Time	Up to 3 hours
Shrub Blades	108mm	Weight	0.53kg
Grass Blades	80mm	Warranty	2 years
Blade Speed	1180rpm		



Features & Benefits



SHRUB SHEAR ATTACHMENT

The shrub shear blades allow quick and easy trimming of topiary, shrubs and bushes around the garden.



GRASS SHEARS ATTACHMENT

The 80mm wide grass blades allow quick and easy trimming around lawn edges and borders.



QUICK RELEASE SYSTEM

The quick release system allows blades to be changed effortlessly by simply pressing the release buttons.

Spreaders

Maintain Shrubs and Lawn Edges

Introducing our comprehensive range of spreaders – your solution for year-round spreading tasks.

From seeds to salt, granular fertilizer to top dressing, our drop and broadcast spreaders offer impressive speed, efficiency, and consistency. Achieve even coverage effortlessly and save time with our versatile and reliable spreaders.

Upgrade your spreading game with our high-quality range for excellent results every season.





The Handy

Push Spreaders



Drop Spreader 27kg (60lbs)

THDS

Blending a low-weight build with a generous 27kg capacity and a sizeable 56cm spread width, the Handy THDS is a fast, low effort way to apply your chosen spread medium over a larger area. Features adjustable feed control for flexibility of use.



Broadcast Spreader 23kg (50lbs)

THS50

Blending a low weight build with smooth rolling pneumatic tyres and an expansive 3.65m spread-width (max.), this easy to use broadcast spreader from Handy is a comfortable and highly productive way to apply your chosen spread-medium! It weighs just 9.4kg and has a 23kg hopper-capacity.



Broadcast Spreader HD 32kg (70lbs)

THS70HDUTY **Quick Assembly**

Featuring robust metal gearing and combining a spacious 32kg-capacity hopper with an impressive 3.66m spread-width (max.), this heavy-duty broadcast spreader from Handy excels in terms of durability and large-area work-rate. Attractive features include pneumatic tyres and a fully adjustable feed-control.

Specifications

Type	Drop Spreader
Capacity	27kg / 60lbs
Spread Width	56cm / 22"
Wheels	30cm / 12"
Drive	Push
Weight	8kg

Type	Broadcast Spreader
Capacity	23kg / 50lbs
Spread Width	Up to 3.65m / 12ft
Wheels	Pneumatic 4.1/3.5-6
Drive	Push
Weight	10.3kg

Type	Broadcast Spreader
Capacity	32kg / 70lbs
Spread Width	Up to 3.65m / 12ft
Wheels	Pneumatic 10x4.1/3.5-4
Drive	Push
Weight	10.6kg

Features & Benefits



ACCURATE SPREAD

Drop spreaders release seed or fertiliser accurately over lawns.



WIDE SPREAD

Broadcast spreaders are ideal for larger areas by throwing the subject outwards, covering a wider spreading pattern.



IDEAL APPLICATION

The flow rate can be adjusted and regulated to suit the required product delivery

Turn to page 30 for our range of salt spreaders for use in the winter months.



Broadcast Spreader 36kg (80lbs)

THS80

A fast, low-effort way to apply your chosen spread medium over a substantial area, the Handy THS80 Broadcast Spreader combines a sizeable 3.66m maximum spread width with a lightweight design and smooth running pneumatic tyres. It has a substantial 36kg hopper capacity and weighs only 12.3kg. Hopper screen and cover included.

Specifications

Type	Broadcast Spreader
Capacity	36kg / 80lbs
Spread Width	Up to 3.65m / 12ft
Wheels	Pneumatic 4.1/3.5-6
Drive	Push
Weight	12.3kg



Broadcast Spreader HD 57kg (125lbs)

THS125HDUTY

Quick Assembly

Of heavy-duty design and combining a huge 57kg hopper-capacity with an expansive 3.66m working-width, this highly productive push-type broadcast spreader from Handy is guaranteed to impress in terms of durability and large-area work-rate! Desirable features include a hopper-cover for successful wet-weather operation; and large pneumatic tyres for a comfortable run over difficult terrain. Weighs 17.5kg. Rust resistant powder coat finish.

Type	Broadcast Spreader
Capacity	57kg / 125lbs
Spread Width	Up to 3.65m / 12ft
Wheels	Pneumatic
Drive	Push
Weight	17.5kg

Features & Benefits



PROTECTION

All broadcast spreaders include a hopper screen to help prevent clogging, and a hopper cover to protect from the elements.



HIGH TRACTION

Large diameter high traction pneumatic tyres offer optimum drive across any surface.



Towed Spreaders



Towed Broadcast Spreader 36kg (80lbs)

THTS

Make your gardening and winter maintenance tasks easier and more efficient. Hook this up to your garden tractor and apply your chosen spread medium over a large area quickly and efficiently. Whether it's lush lawns or ice-free pathways you desire, this versatile tool has you covered.

Specifications

Type	Broadcast Spreader
Capacity	36kg / 80lbs
Spread Width	Up to 3.65m / 12ft
Wheels	Pneumatic 4.1/3.5-6
Drive	Towed
Weight	10.7kg



Towed Broadcast Spreader 80kg (175lbs)

THTS175

The towed broadcast-spreader from Handy can be used during the growing-season for the application of fertiliser, pesticide and grass-seed; while during the winter months, you can broadcast salt to help keep your paths, driveway and other hard-surface areas ice-free. It features an aluminium gear box and rust resistant powder coat finish.

Type	Broadcast Spreader
Capacity	80kg / 175lbs
Spread Width	Up to 3.65m / 12ft
Wheels	Pneumatic 35.5cm / 14"
Drive	Towed
Weight	24kg

Features & Benefits



IDEAL FOR LARGE AREAS

Simply hitch the spreader to your garden tractor or ride on mower to cover large areas with ease.



MULTI-SEASONAL USE

Helps you to maintain a healthy lawn by evenly distributing fertilisers and seeds. When winter arrives, it becomes an essential tool for keeping your paths clear of ice.





All Season Spreaders

All Season Spreaders



All Season Spreader HD 32kg (70lbs)

THS70SALHDUTY

Quick Assembly

This heavy-duty 70lb salt push spreader, is perfect for efficiently distributing refined ice-melting salt, fertilizers, granules, grass seeds, and more. Its adjustable feed control allows precise spreading, while the 3.05m spread width covers large areas quickly. With pneumatic wheels and a stainless steel frame, it glides smoothly even on rough surfaces.

Specifications

Type	Broadcast Spreader
Capacity	32kg / 70lbs
Spread Width	Up to 3.65m / 12ft
Wheels	Pneumatic
Drive	Push
Weight	10.9kg



All Season Salt Spreader 36kg (80lbs)

THSS80

Say goodbye to the hassles of icy conditions with our compact yet incredibly efficient hand-propelled salt spreader. A fast, low-effort way to apply your chosen spread medium over a substantial area. The Broadcast Spreader combines a sizeable 3.66m maximum spread width with a lightweight design and smooth running pneumatic tyres. It has a substantial 36kg hopper which includes a screen and cover.

Type	Broadcast Spreader
Capacity	36kg / 80lbs
Spread Width	Up to 3.65m / 12ft
Wheels	Pneumatic
Drive	Push
Weight	10.4kg

Features & Benefits



REDUCE CLOGGING

Materials can become clogged, thankfully the hopper screen reduces blockages.



CORROSION RESISTANT

All The Handy salt spreaders feature robust stainless steel frames for durability.



ADJUSTABLE FEED CONTROL

To ensure the correct amount of material is released the handles feature a feed control lever.



All Season Salt Spreader 45kg (100lbs)

THSS100

Enjoy an even faster large-area work-rate with this 45kg capacity salt spreader from The Handy! It delivers an expansive 3.65m maximum spread width and is designed with careful attention to build quality. The spreader blends heavy-duty stainless-steel gearing with a stainless-steel axle and frame, and corrosion- and impact-resistant polypropylene hopper.

Specifications

Type	Broadcast Spreader
Capacity	45kg / 100lbs
Spread Width	Up to 3.65m / 12ft
Wheels	Pneumatic
Drive	Push
Weight	12.5kg



All Season Salt Spreader HD 57kg (125lbs)

THS125SALTDUTY

Quick Assembly

Get top-of-the-range productivity and cover a large area fast with this 57kg capacity salt spreader from The Handy! You'll enjoy a substantial 3.65m maximum spread width and a durable reinforced gearing system. With a heavy duty stainless steel frame the THS125SALTDUTY is built to last.

Type	Broadcast Spreader
Capacity	57kg / 125lbs
Spread Width	Up to 3.65m / 12ft
Wheels	Pneumatic
Drive	Push
Weight	17.5kg

Features & Benefits



HOPPER COVER

To allow for working in any conditions, all models include a waterproof hopper cover.



ACCURATE APPLICATION

The all season spreaders feature adjustable deflectors to give total control over where salt is applied.



Compare Spreaders

Compare various spreader models to discover the perfect fit for your needs.



Specifications

Model	THDS	THS50	THS70HDUTY	THS80	THS125HDUTY
Type	Drop Spreader	Broadcast Spreader	Broadcast Spreader	Broadcast Spreader	Broadcast Spreader
Capacity	27kg / 60lbs	23kg / 50lbs	32kg / 70lbs	36kg / 80lbs	57kg / 125lbs
Suitable for Seed	✓	✓	✓	✓	✓
Suitable for Fertiliser	✓	✓	✓	✓	✓
Suitable for Ice Melt	X	X	X	X	X
Spread Width	Up to 56cm / 22"	Up to 3.65m / 12ft	Up to 3.65m / 12ft	Up to 3.65m / 12ft	Up to 3.65m / 12ft
Adj. Deflectors	X	X	X	X	X
Frame Material	Steel	Steel	Steel	Steel	Steel
Hopper Material	Polypropylene	Polypropylene	Polypropylene	Polypropylene	Polypropylene
Hopper Cover	X	✓	✓	✓	✓
Hopper Sieve	X	✓	✓	✓	✓
Drive	Push	Push	Push	Push	Push
Hitch Type	n/a	n/a	n/a	n/a	n/a
Wheels	Pneumatic	Pneumatic	Pneumatic	Pneumatic	Pneumatic
Weight	8kg	10.3kg	10.6kg	12.3kg	17.5kg
Dimensions (LWH)	74 x 83 x 100cm	54 x 85 x 107cm	105 x 56 x 97cm	49 x 81 x 82cm	111 x 77 x 103cm
Quick Assembly	X	X	✓	X	✓



THTS	THTS175	THS70SALTHDUTY	THSS80	THSS100	THS125SALTHDUTY
Broadcast Spreader	Broadcast Spreader	Broadcast Spreader	Broadcast Spreader	Broadcast Spreader	Broadcast Spreader
36kg / 80lbs	80kg / 175lbs	32kg / 70lbs	32kg / 70lbs	32kg / 70lbs	32kg / 70lbs
✓	✓	✓	✓	✓	✓
✓	✓	✓	✓	✓	✓
X	X	✓	✓	✓	✓
Up to 3.65m / 12ft	Up to 3.65m / 12ft	Up to 3.65m / 12ft	Up to 3.65m / 12ft	Up to 3.65m / 12ft	Up to 3.65m / 12ft
X	X	✓	✓	✓	✓
Steel	Steel	Stainless Steel	Stainless Steel	Stainless Steel	Stainless Steel
Polypropylene	Polypropylene	Polypropylene	Polypropylene	Polypropylene	Polypropylene
✓	✓	✓	✓	✓	✓
✓	✓	✓	✓	✓	✓
Towed	Towed	Push	Push	Push	Push
Pin Hitch	Pin Hitch	n/a	n/a	n/a	n/a
Pneumatic	Pneumatic	Pneumatic	Pneumatic	Pneumatic	Pneumatic
10.7kg	24kg	10.9kg	10.4kg	12.5kg	17.5kg
105 x 48 x 66cm	126 x 87 x 91cm	105 x 56 x 07cm	58 x 83 x 94cm	69 x 76 x 108cm	111 x 76 x 102cm
X	X	✓	X	X	✓

Tillers

The secret to effortless digging

Experience the joy of evenly aerated, weeded, and prepared flower and vegetable plots with our reliable tillers. Say goodbye to manual labour and enjoy the satisfaction of beautifully prepared soil.

Make your gardening tasks easier and more rewarding with our powerful and efficient tillers.





**Achieve well-aerated, weed-free
flower and vegetable beds
with the help of our trusted tillers**

2-Stroke Petrol Mini Tiller

THPMT

Effortless soil preparation

Equipped with a large displacement 43cc two-stroke engine and boasting a compact 30cm working width, this top-quality petrol mini tiller from Handy offers the perfect compromise between power and manoeuvrability. Its low weight build and fingertip control ensure it excels in terms of handling; while the provision of transport wheels and a folding handlebar make it simple to move and store. The Handy THPMT weighs in at only 15kg.



Specifications

Engine	2-Stroke Petrol	Transport Wheels	Yes
Power	42.7cc (1.2kW)	Folding Handles	Yes
Tilling Width	30cm / 12"	Fuel Tank Capacity	1.2 Litres
Tilling Depth	20cm / 8"	Runtime per tank	approx 60mins
Tines	4 x 6 tooth	Weight	15kg
Tine Diameter	22.5cm	Warranty	2 years



Features & Benefits



DIGGING POWER

The 42.7cc petrol 2-stroke engine provides plenty of power to dig and turn soil with ease.



EFFORTLESS TILLING

The specially designed 6 teeth tines offer exceptional tilling performance leaving a fine rich soil for planting.



EASY TRANSPORT

The integrated transport wheels of the THPMT allow for easy manoeuvring to and from the work area.

Electric Tiller

THET

With its powerful 800w motor driving a series of four sharp tipped steel rotors giving a 30cm working width, this lightweight and easy-handling electric tiller from Handy will make the life of the home veg-grower a whole lot easier!

Specifications

Motor	800 W
Tilling Width	30cm / 12"
Tilling Depth	20cm / 8"
Tines	4 x 4 tooth
Transport Wheels	No
Weight	8.1kg



Electric Tiller 1400 THET1400

Enjoy the powerful performance provided by a 1400w electric motor and the superior productivity offered by a sizeable 43cm working-width with the Handy THET1400 Electric Tiller! Desirable features include removable tines for enhanced flexibility; hardened steel tines for durability; and transport wheels for easy manoeuvrability.

Specifications

Motor	1400 W
Tilling Width	up to 43cm / 17"
Tilling Depth	20cm / 8"
Tines	6 x 4 tooth
Transport Wheels	Yes
Weight	14kg



Features & Benefits



COMPACT YET POWERFUL

The electric range of Handy tillers have a compact size yet deliver exceptional digging performance around the garden.



EASY STORAGE

The handles have been designed to fold completely leaving a small footprint for storage in the garage or garden shed.



DUAL POSITION WHEELS

The wheels of the THET1400 feature dual positions, down for transportation and raised when digging.

Log Splitters

Effortless Log Preparation

Our comprehensive line-up of logging equipment is designed to make log preparation for your wood burner, open fire, or cooking range safe, comfortable, and hassle-free. With a wide range of log splitters available, including foot pedal operated models and high-performance electric machines, we have the perfect tool for every need. From swift and efficient vertical splitters to versatile horizontal ones, our log splitters will effortlessly power through your woodpile, saving you time and effort.



Don't miss our range of saw horses and saw benches to make cutting logs for splitting even easier on page 44.



Log Splitters



Log Splitter 4 Ton

THLS-4G

The Handy THLS-4G Log Splitter has a 1500 watt electric motor and is compact enough to be stored easily in either your shed or garage. With its 4 ton capacity, this log splitter has been designed and manufactured to quickly and easily split logs, saving you time when preparing firewood. It is capable of splitting logs up to 370mm in length and 250mm diameter with the minimum effort and maximum safety thanks to the two-handed operation and protective log cage.

Log Splitter 6 Tonne

THLS-6G

The Handy THLS-6G Log Splitter has a larger 2200 watt electric motor yet is still compact enough to be stored easily in either your shed or garage. With an increased 6 tonne capacity, this log splitter has been designed and manufactured to quickly and easily split longer logs, saving you time when preparing firewood. It is capable of splitting logs up to 520mm in length and 250mm diameter with the minimum effort and maximum safety thanks to the two-handed operation and protective log cage.

Specifications

Motor	1500 W
Splitting Force	4 ton
Max Splitting Length	37cm
Max Log Diameter	25cm
Stroke Length	22cm
Weight	38kg

Motor	2200 W
Splitting Force	6 ton
Max Splitting Length	52cm
Max Log Diameter	25cm
Stroke Length	37cm
Weight	57.5kg

Features & Benefits



SAFETY FIRST

As well as the protective cage, the two handed operation ensures the operator is always clear of harms way.



TRANSPORT WHEELS

All Handy log splitters feature sturdy integrated wheels to allow for easy transportation.



4-WAY SPLITTING WEDGE

The optional 4-way splitting wedge increases productivity by splitting logs into 4 pieces with a single pass.



Log Splitter Vertical 7 Tonne

THLSV7

The Handy THLSV7 has a powerful 3000-watt electric motor, producing 7 ton of splitting force, with the ability to split logs that are up to 55cm long and 30cm in diameter, this is a serious assistant for splitting logs for your wood burner or open fire. It has an adjustable splitting table that can be used in three different positions which will give you the ability to split logs of various sizes. You can fit a 4-way splitting wedge for faster splitting of large quantities of logs.

Log Splitter Vertical 8 Tonne

THLS8TE

The Handy THPLS8TE is powered by 3000-watt electric motor, it is a vertical log splitter making it ideal for domestic users who need to split larger logs to a size more suitable for their open fire or wood burning stove. With its massive 8 ton of splitting pressure, you will be able to work through a large pile of logs quickly and efficiently, it can split logs from 80mm – 300mm in diameter and 100-550mm in length. The log splitter is easily moved around thanks to its transport wheels and handy handle.

Specifications

Motor	3000 W
Splitting Force	7 ton
Max Splitting Length	55cm
Max Log Diameter	30cm
Stroke Length	49.5cm
Weight	101.4kg

Motor	3000 W
Splitting Force	8 ton
Max Splitting Length	55cm
Max Log Diameter	30cm
Stroke Length	48.5cm
Weight	111.5kg

Features & Benefits



SPLIT LARGE LOGS SAFELY

The Handy vertical splitters are capable of splitting larger logs quickly and safely thanks to the two handed operation to grip the wood.



THE PERFECT ACCESSORIES

View page 48 for our log splitter accessories, including The Handy log cart, perfect to stack freshly split logs for quick and easy transport.



Log Splitter Accessories

Upgrade your Log-splitting experience

Our trio of log splitter accessories enhances log preparation and offers added convenience.

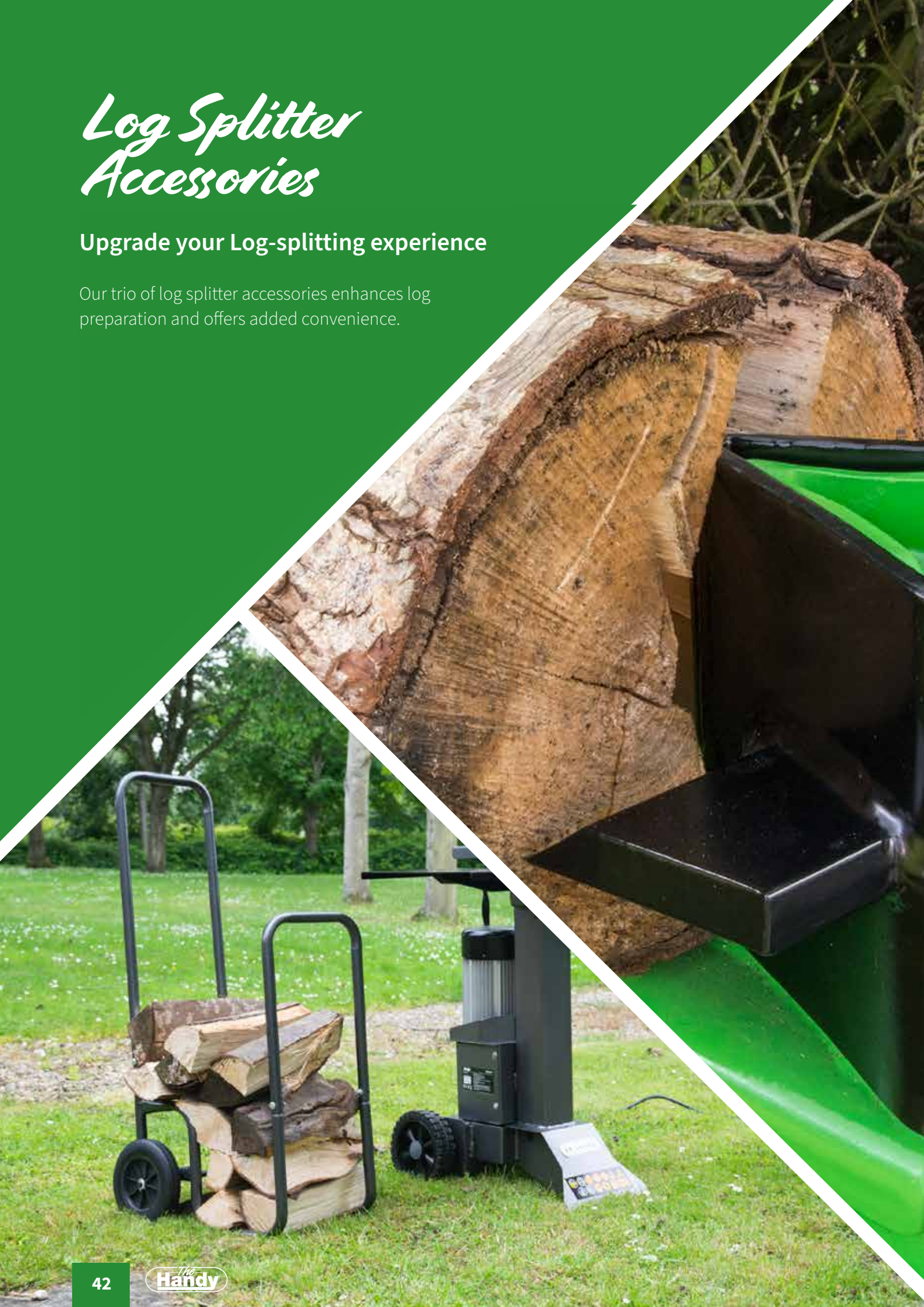

4-Way Splitting Wedge

TH65510 (Horizontal)

TH66525 (Vertical)

The Handy four way splitting wedge will speed up the splitting of your larger logs and to give more manageable log pieces for your wood burner or open fire. Available for both horizontal and vertical models.

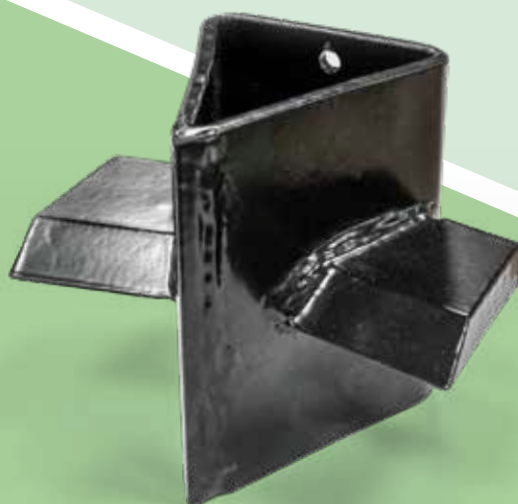

Log Cart with Cover

THLC

If you have an open fire or are running a wood-burner, this practical and convenient log-cart from Handy will make your life a whole lot easier!



Log Splitter Table

THLS-TABLE

Quality steel log splitter table designed to make splitting safe and easy whilst saving you having to bend down while working.

Suitable for The Handy horizontal log splitter models: THLS-4, THLS-4G, THLS-6 and THLS-6G.



Saw Horses & Benches

Essential Sawhorse for Workshop and Garden Woodcutting

Whether you're a DIY enthusiast, carpenter, or homeowner working on projects, making repairs, or needing support for timber or logs, a sawhorse can make light work of your endeavours.

Designed to provide a stable and secure platform, a sawhorse ensures safety and efficiency while allowing you to tackle your DIY and garden projects with ease.





Log Saw Bench

THSBENCH-G

Welcome to the quickest & safest way to cut logs

If you have an open-fire or are running a wood burner and have had enough of breaking your back preparing the logs you need, the 2200w Electric Saw-Bench provides the perfect solution!



Specifications

Motor	240 V	Blade Speed	2800 rpm
Power	2200 W	Length Stop	Adjustable
Blade Size	40.5cm	Dimensions	100 x 20 x 70
Saw Teeth	40	Cable Length	10 m
Log Capacity	14cm diameter	Weight	36.3kg
Max Log Length	100cm	Warranty	2 years



Features & Benefits



THE FASTEST CUT

The large 40 tooth blade features tungsten carbide tips for a clean cut and superb durability.



LOGS UP TO 1 METRE

The integrated log holder can support logs up to 1 metre in length



ADJUSTABLE LENGTH STOP

Ensure logs are all cut to the same length with the adjustable length stop.

Foldable Saw Horse

THBSH

The Handy saw horse brings the subject-log up to waist-height, thereby eliminating the need for backache-inducing bending; and it benefits from a galvanised finish that provides long-term corrosion-resistance. The THBSH has serrated edges which ensure the log is held securely in position as you cut.

Specifications

Type	Foldable Saw Horse
Weight Capacity	100kg
Max Log Diameter	30cm
Material	Galvanised Steel
Foldable	Yes
Weight	5.5kg



Saw Horse with Chainsaw Support

THSHWCS

This saw-horse/chainsaw-support combination from The Handy not only holds the subject-log at waist-height for comfortable cutting, it also provides a mount for your chainsaw, thereby making the job faster, safer and less tiring.

Specifications

Type	Saw Horse c/w Holder
Weight Capacity	120kg
Max Log Diameter	25cm
Max Bar Length	45cm / 18"
Foldable	Yes
Weight	10kg



Features & Benefits



TOTAL SAFETY

The THSHWCS features a chainsaw holder for bars up to 45cm. Simply mount the chainsaw and cut logs to length.



IDEAL FOR STORAGE

The Handy saw horses fold flat for storage, taking up minimal space in the shed or garage when not in use.



CUT LOGS FAST

Saw horses allow fast and safe cutting of logs, perfect for use in a wood burner or in preparation for splitting.

Shredders & Chippers

Efficient Garden Waste Management

Our handy garden shredders not only save you time and effort, but the mulch they produce also provides numerous benefits for your garden. This finely shredded material is highly valuable as it enriches the soil, improves moisture retention, and suppresses weed growth. It's a sustainable way to recycle and repurpose your garden waste while enhancing the health and appearance of your outdoor space.

With The Handy shredders, you can say goodbye to cumbersome debris and hello to a convenient and eco-friendly method of managing your garden waste.





Garden Shredder 2500W

THISWB

The easy way to clear up garden waste

With the powerful 2500w Handy Electric Impact Shredder, grass-clippings, hedge trimmings, leaves - and even branches up to a sizeable 45mm in diameter - can all be reduced to a mulch that will prove easy to dispose of; and which will act as an effective compost for your flowerbeds and veg-plot!



Specifications

Motor	240 V	Transport Wheels	Yes
Power	2500 W	Hopper	Yes including plunger
Blade Speed	4500 rpm	Cable	3 M
Max Capacity	45mm diameter	Dimensions	46 x 36 x 123
Collector	Integrated Box	Weight	13.8kg
Collector Capacity	40 L	Warranty	2 years



Features & Benefits



HIGH IMPACT SHREDDING

The twin blades spin at 4500rpm, slicing through material to produce a fine mulch that can be used around the garden.



NO MESS

The THISWB features an integrated 40 L collector to catch shredded material, once full simply remove the collector to empty.

Includes a safety switch on the handle.



SHRED BRANCHES AND GREEN MATERIAL

Shredding of woody material is easy via the hopper opening, for greener leafy material the included plunger allows easy feeding.

Petrol Chipper / Shredder

THPDS65

Tackles even the toughest garden waste

With its immensely powerful 208cc Briggs & Stratton engine driving two drum mounted blades via high-torque V-belt drives, the Handy THPDS65 Petrol Chipper-Shredder will handle large volumes of thick, woody debris with the utmost speed and efficiency!



Specifications

Engine	Briggs & Stratton	Transport Wheels	Yes
Power	208cc	Discharge Chute	Adjustable
Transmission	Parallel Twin V-Belts	Tyres	Pneumatic
Cutting System	2 rotating - 1 static blade	Dimensions	123 x 106 x 51.5
Max Capacity	60mm diameter	Weight	52.5kg
Collector	N/A	Warranty	2 years



Features & Benefits



ULTIMATE CHIPPING

The drum cutting system features twin heavy duty chipping blades to cut through woody material up to 60mm in diameter.



TRUSTED POWER

The heavy duty Briggs & Stratton XRD950 engine delivers the tried and tested power which is required for a performance chipper.



HEAVY DUTY - EASY TO MOVE

The large pneumatic wheels allow the chipper to be easily transported to any location.

Garden Sprayers

Protecting your plants from disease

The Handy sprayers range stands as your dependable ally, offering an array of options to meet your plant protection needs - ensuring that your plants remain free from diseases and pests.

The Handy sprayers are crafted with user convenience in mind. You'll find comfort in their ergonomic designs, easy-to-use features, and efficient spray patterns.





Knapsack Sprayer

THKS16LTR

Plant protection at its best

Our knapsack sprayer arrives fully equipped with essential components, including a lance, trigger, and an assortment of adaptable nozzles. This comprehensive set empowers you to achieve precise spray patterns tailored to the demands of diverse tasks, whether you require focused jet sprays for targeted treatment or wide-cone coverage for broader applications.

The Sprayer boasts thoughtfully designed shoulder straps that provide ergonomic support, ensuring you can comfortably and effectively carry the 16-litre load, even during prolonged sessions.



Specifications

Type	Backpack Sprayer
Capacity	16 L
Pressure	0.2-0.4 MPA
Pump Lever	Left or Right
Release Valve	Yes

Trigger Lock	Yes
Shoulder Strap	Yes
Power	hand
Dimensions	36x19x50cm
Weight	1.4kg
Warranty	2 years



Features & Benefits



PUMP LEVER

The extended pump lever makes it easy to build pressure, with the added ability to be mounted to the left or right of the sprayer.



WIDE EASY FILL OPENING

The extra wide opening ensures filling the sprayer is quick and easy without spillages.



INCLUDES VARIOUS NOZZLES

With a variety of nozzles to suit the application from targeted focused jet spray to wide cone coverage.

Pump Sprayer 2L

THS2LTR

The Handy 2 Litre Pump Sprayer is the perfect solution for smaller spraying tasks, whether it's tending to houseplants, working in the greenhouse, or tending to your garden.

Specifications

Type	Pump Sprayer
Capacity	2 L
Release Valve	Yes
Nozzle	Adjustable
Lance	No
Weight	0.35kg



Pressure Sprayer 5L

THS5LTR

Whether you're a seasoned gardener or professional, this 5 Litre Pressure Sprayer is your ultimate choice for precise and efficient spraying.

Specifications

Type	Pump Sprayer
Capacity	5 L
Release Valve	Yes
Nozzle	Adjustable
Lance	Yes
Weight	1kg



Features & Benefits



PRESSURE RELEASE VALVE

All The Handy sprayers feature an integrated pressure relief valve to protect from over pressuring.



LARGE PUMP HANDLE

The THS5LTR pressure sprayer features a large pump handle to build pressure with minimum effort.

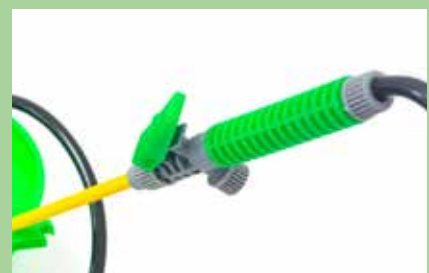

ON/OFF FLOW CONTROL

The spraying lance of the THS5LTR features an on/off flow control lever for accurate spraying.

Garden Trolleys, Trucks & Trailers

Get things moving with The Handy's transportation equipment

Our collection includes trailers, sack trucks, carts and trolleys all built with superior quality and durability in mind. Whether you're gardening or working on a DIY project, we have the right product for you. With features like corrosion-proof beds, strong steel frames, manoeuvrable tyres and drop-down sides for easy loading and unloading, our equipment ensures efficient and hassle-free movement of materials. Choose The Handy for reliable and high-quality transportation solutions.





The Handy

Garden Trolleys



Poly Dump Cart

THPDC

The attractively priced Handy THPDC Garden Trolley features a corrosion-resistant poly body and offers easy manoeuvrability thanks to its turntable steering and sizeable puncture proof tyres. It boasts a generous 200kg capacity and features a convenient tipping system.

Specifications

Type	Hand / Towed Trolley
Capacity	200kg / 440lbs
Features	Tipping Poly Bed
Towed	Yes
Wheels	4 x Puncture Proof
Dimensions	109 x 60 x 60
Weight	24kg



Garden Trolley

THGT

A versatile and robust Trolley designed for small to medium gardens. Crafted with steel construction, this garden cart boasts exceptional strength and durability, ensuring it stands the test of time. Transporting logs, plants, tools, bags of compost, garden waste, and more has never been easier.

Type	Hand / Towed Trolley
Capacity	200kg / 440lbs
Features	Removable Sides
Towed	Yes
Wheels	4 x Puncture Proof
Dimensions	109 x 50 x 60
Weight	20kg

Features & Benefits



HIGH MANOEUVRABILITY

The pivoting front wheels offer greater control while transporting goods around the garden.



EASY TIPPING

Heavy loads can be tipped to save time via the single tipping lever.



ALWAYS READY

Each trolley features 4 large puncture proof tyres to ensure you are always ready to work.

All trolley tyres are designed to be puncture proof



Large Garden Trolley

THLGT

Enjoy a huge 350kg load-capacity, rugged build-quality and easy manoeuvrability with the Handy THLGT Large Garden-Trolley! It can be pushed, pulled or tractor-towed; and it features drop-down sides for ease of use.

Specifications

Type	Hand / Towed Trolley
Capacity	350kg / 770lbs
Features	Removable Sides
Wheels	4 x Puncture Proof
Dimensions	140 x 64 x 65
Weight	31kg

Optional liner available: **THLGT-LINER**

Features & Benefits



HINGED SIDES

All models feature hinged sides for easier loading, with the ability for removal if you need a flat bed. (excludes THPDC).



Multi Purpose Cart

THMPC

Get fantastic versatility, rock solid build quality and an impressive load capacity with this multi purpose garden cart from Handy! It holds up to 300kg and features drop down sides and a tipping mechanism for straightforward loading and unloading.

Type	Hand / Towed Trolley
Capacity	300kg / 661lbs
Features	Includes Poly Liner
Tipping bed	Yes
Towed	Yes
Wheels	4 x Puncture Proof
Dimensions	123 x 61 x 101
Weight	35kg



TRULY VERSATILE

The THDLGT offers additional versatility with a removable bed liner and an additional tool tray.



Deluxe Garden Trolley

THDLGT

Your heavy-duty workhorse with a massive 400kg load capacity, sturdy build, and easy maneuverability. It comes with a removable liner for effortless cleaning and a tool tray for quick access to your essentials. Say goodbye to heavy lifting and hello to efficiency in your garden tasks!

Type	Hand / Towed Trolley
Capacity	400kg / 880lbs
Features	Liner & Tool Tray
Towed	Yes
Wheels	4 x Puncture Proof
Dimensions	126 x 63 x 64.5
Weight	26kg



Trucks

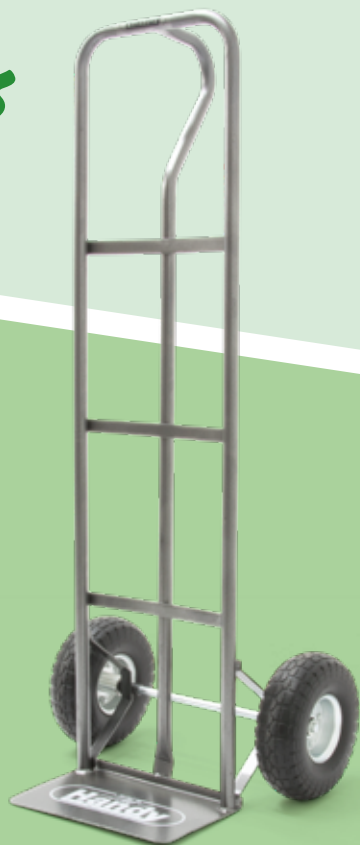

Sack Truck

THST

With its ergonomic 'P' handle, large pneumatic tyres and sizeable lifting-plate, The Handy Sack Truck ticks all the boxes in terms of comfort, manoeuvrability and capacity!

Folding Sack Truck

THFST

Puncture Proof Tyres

With a fold up toe plate and retractable handlebars, The Handy Sack Truck is easy to store and will prove comfortable to use for any operator! It weighs just 10kg unloaded and has a huge 200kg capacity.

Specifications

Type	Sack Truck
Capacity	200kg / 440lbs
Wheels	Puncture Proof 25cm
Features	'P' Handle
Dimensions	46.5 x 54 x 131
Weight	10kg

Type	Sack Truck
Capacity	200kg / 440lbs
Wheels	Puncture Proof 25cm
Features	Wheel Guards & Storage Mode
Dimensions	51.5 x 48.5 x 111
Weight	10kg

Features & Benefits



ALWAYS READY

Each Handy sack truck features large puncture proof tyres to ensure you are always ready to work.



ALWAYS STABLE

The large front plate ensures goods are always stable during transport, from boxes, pots, and even white goods.



FOLDS TO NOTHING

The THFST features a unique storage mode where the front plate lifts and the handles slide down to minimize size.

Trailers



Garden Trailer

THGT500

Make the most of your garden tractor and transport heavy and/or bulky loads the easy way with this high quality but affordable towed tipping trailer from Handy! It has a substantial 225kg capacity and is supplied with a universal hitch-pin.

Specifications

Type	Towed Trailer
Capacity	225kg / 500lbs
Features	Removable Sides & Tipping
Wheels	16" Pneumatic
Dimensions	157 x 80.6 x 76.7
Weight	38kg



Towed Poly Dump Cart

THTPDC

The Handy THTPDC features an impact and corrosion resistant poly body and can be converted from push to tow by simply unfolding the hitch bar. It's capable of holding a huge 295kg and weighs just 28.6kg when empty.

Type	Towed Dump Cart
Capacity	295kg / 650lbs
Features	Poly Body & Tipping
Wheels	16" Pneumatic
Dimensions	102.5 x 76.5 x 27.5
Weight	25kg

Features & Benefits



FITS MOST GARDEN TRACTORS

The universal pin hitch quickly connects to the tow bar of most garden tractors.



EMPTYING LOADS IS EASY

The Handy trailers feature a tipping function to effortlessly empty heavy loads.



Vacuums

Effortlessly tackle any cleaning task with The Handy's ash vacuum cleaners and wet & dry vacuum

Our new collection of products includes powerful stainless steel ash vacuum cleaners - an efficient solution designed to make light work of clearing ash from fireplaces, barbecues, log burners and garden chimineas.

Looking for something more versatile? Our new wet & dry vacuum is the ultimate solution for tackling heavy duty cleaning.





10 Litre Stainless Steel Ash Cleaner

NEW for
2025

THAV80010L

A mess-free, efficient solution for tackling ash.

Effortlessly tackle ash clean-up with The Handy 10 Litre Ash Cleaner THAV80010L. Designed with convenience and power in mind, this 800W ash vacuum simplifies the task of cleaning fireplaces, log burners, barbecues, garden chimineas, and more, saving you from the hassle of a dustpan and brush. With a 10-litre capacity, it allows for longer cleaning sessions without constant emptying. The vacuum's powerful suction of 15 kPa ensures even fine ash particles are efficiently collected.

The 1-metre hose and 6-metre power cable provide flexibility and easy reach, while the durable handle makes it portable and easy to store. Say goodbye to ash debris and hello to effortless cleaning with this versatile, user-friendly ash cleaner.



Specifications

Power Source	Mains
Power	800W
Cleaning	Suitable for vacuuming ash
Capacity	10 Litres
Vacuum suction	15 kPa

Cable Length	6 Metres
Hose	1 Metre
Tank	Stainless Steel
Handle	Yes



Features & Benefits



ASH VACUUM

Designed with convenience and power in mind, this ash vacuum simplifies the task of cleaning.



POWERFUL 800W MOTOR

Powered by an 800W motor, it provides efficient suction for quick and thorough ash removal.



DURABLE STAINLESS-STEEL TANK

Combines durability and easy cleaning with a convenient length for manoeuvrability.

15L Wet Stainless Steel Ash Cleaner

NEW for
2025

THAV120015L

Effectively capture fine ash particles for a pristine clean.

The Handy 15 Litre Ash Cleaner THAV120015L is a 1200W ash vacuum designed for effortless cleaning of fireplaces, barbecues, log burners, and garden chimineas. With a 15-litre capacity, and powerful 18 kPa suction, this mains-powered cleaner provides a mess-free, efficient solution for tackling ash. Includes a 1-metre hose, 6-metre cable, and a sturdy handle for easy portability.



Specifications

Power Source	Mains
Power	120)W
Cleaning	Suitable for vacuuming ash
Capacity	15 Litres
Vacuum Suction	18 kPa

Cable Length	6 Metres
Hose	1 Metre
Handle	Yes
Tank	Stainless Steel



Features & Benefits



1-METRE HOSE

Offers flexibility to reach tight spaces and distant areas easily. High suction power of 18KPA.



POWERFUL 1200W MOTOR

Powered by a 1200W motor, it provides efficient suction for quick and thorough ash removal.



DURABLE STAINLESS-STEEL TANK

Combines durability and easy cleaning with an extra cable length for manoeuvrability.

15L Wet & Dry Stainless Steel Vacuum Cleaner

NEW for
2025

THWD1250

Ideal for both wet and dry cleaning tasks.

The Handy 15-Litre Wet & Dry Vacuum Cleaner THWD1250 is designed for heavy-duty cleaning, offering a versatile solution for both wet and dry messes. Powered by a 1250W motor, it provides an impressive 15 kPa suction power, ensuring thorough and efficient cleaning. The 15-litre stainless steel container accommodates large volumes of liquids, dirt, dust, and debris.

Equipped with a 1.5m hose, this vacuum cleaner allows you to clean hard-to-reach places effortlessly. It's ideal for dealing with various materials, including sawdust, metal shavings, wood chippings, and spillages. The long 15-metre cable provides excellent mobility.



Specifications

Power Source	Mains	Cable Length	15 Metres
Power	1250W	Hose	1.5 Metres
Cleaning	Wet & Dry	Fill Indicator	Yes
Capacity	15 Litre	Handle	Yes
Vacuum Suction	15 kPa	Tank	Stainless Steel



Features & Benefits



WET & DRY VACUUM CLEANING

Versatile design enables easy handling of liquids, dust, dirt, debris, and more, making it ideal for various environments.



POWERFUL 1250W MOTOR

Powered by a 1250W motor, it provides an impressive 15 kPa suction power, ensuring thorough and efficient cleaning.



15-LITRE STAINLESS STEEL TANK

The 15-litre stainless steel container accommodates large volumes of liquids, dirt, dust, and debris.









Would you like additional advice?

Your The Handy Dealer in your area is ready to assist you in selecting the perfect product to suit your needs. They also offer after-sales service, including spare parts availability.

Locate your local authorised Dealer online at www.thehandy.co.uk



The Handy
Murdock Road, Swindon, Wiltshire SN3 5HY
Email: cs@thehandy.co.uk

E&OE
Product specification may change without prior notice.
All photographs are used for illustrative purposes only, actual product may vary.